

# Signet 9900 Transmitter



Member of the SmartPro® Family of Instruments



Panel Mount

Field Mount

The Signet 9900 Transmitter provides a single channel interface for many different parameters including Flow, pH/ORP, Conductivity/Resistivity, Salinity, Pressure, Temperature, Level, Dissolved Oxygen, and other sensors that output a 4 to 20 mA signal. The 9900-1P Transmitter can also be used as a Batch Controller when a Batch Module and Relay Module are installed.

The 9900 is offered in both panel or field mount versions. Both configurations offer an extra large (3.90" x 3.90") auto-sensing backlit display features "at-a-glance" visibility that can be viewed at 4-5 times the distance over traditional transmitters. The highly illuminated display and large characters reduce the risk of misreading or misinterpreting the displayed values. The display shows separate lines for units, main and secondary measurements as well as a "dial-type" digital bar graph.

The 9900 can run on 12 to 32 VDC power (24 VDC nominal), and can also be loop powered with compatible sensors.

Rear Enclosure kits are available for the 9900-1P Panel Mount. Kit options include either a Hinged Cover (3-9900.399-1) for wall or pipe mount installations, or a Flat Cover (3-9900.399-2) designed to fit inside a panel for waterproof protection.

The 9900 offers complete flexibility, plug-in modules allow the unit to easily adapt to meet changing customer needs. Optional modules include the new Modbus as well as the Relay, Direct Conductivity/Resistivity, H COMM, Batch, 4 to 20 mA Output, and a PC COMM Configuration Tool. The unit can be used with default values for quick and easy programming or can be customized with labeling, adjustable minimum and maximum dial settings, and unit of measure and decimal location choices.

## Features

- **NEW! Modbus Module** supports RS485 Serial Modbus Communications
- **Multiple sensor types supported with one instrument**
- "Dial-type" digital bar graph
- **Modules are field installable and replaceable anytime**
- **Optional Relay Module** for addition of two dry contact relays
- **Optional H COMM Module** for two-way communication
- **Optional Batch Module** for Batch Control
- **Modbus Module** for connection to Serial, RS485, Modbus networks
- **One 4 to 20 mA output in base unit. One additional 4 to 20 mA available with optional module**
- **Rear Enclosure kits** for panel, wall or pipe mounting
- **Warning and Relay LED indicators** for "at a glance" visibility
- **Customizable features** including digital label for custom identification
- **Optional PC COMM configuration tool** for configuration at a PC



## Applications

- **Wastewater Treatment**
- **Reverse Osmosis**
- **Deionization**
  - Ultra Pure Water
  - Two Bed System
  - Mixed Bed System
- **Chemical Manufacturing/Addition**
- **Metal and Plastic Finishing**
- **Fume Scrubber**
- **Cooling Towers**
- **Media Filtration**

# Specifications

General			
Input Channels	One		
Input Types	Digital (S <sup>3</sup> L)	Serial ASCII, TTL level, 9600 bps	
	Frequency	Range	0.5 to 1500 Hz
		Accuracy	0.5% of reading
Measurement Types	Flow, pH/ORP, Conductivity/Resistivity, Salinity, Pressure, Temperature, Level, Dissolved Oxygen, Batch or user-defined (via 8058)		
Enclosure and Display			
Case Material	PBT		
Window	Shatter-resistant glass		
Keypad	4 buttons, injection-molded silicone rubber seal		
Display	Backlit, 7 and 14-segment		
Update Rate	1 s		
LCD Contrast	5 settings		
Indicators	"Dial-type" digital bar graph. LEDs for Open Collector, Relays and Warning Indicator		
Enclosure Size	¼ DIN		
Mounting	9900-1P		
	Panel	¼ DIN, ribbed on four sides for panel mounting clip inside panel, silicon gasket included. Optional rear enclosure with flat cover available for waterproof protection when installed inside a panel.	
	Wall	Options include 9900-1P installed in pre-wired NEMA enclosure, wall mount enclosure or inside of rear enclosure with hinged cover. (USA Only)	
	Pipe	Optional Rear Enclosure with hinged cover and 9900-1P for pipe mount installation	
Mounting	9900-1		
	Field (Integral)	Options include yellow universal or integral kits for installation with sensor	
Display Ranges			
pH	0.00 to 15.00 pH		
pH Temperature	-39.99 °C to 149.99 °C	-40 °F to 302 °F	
ORP	-1999 to +1999 mV		
Flow Rate	-9999 to 99999 units per second, minute, hour or day		
Totalizer	0.00 to 99999999 units		
Conductivity	0.0000 to 99999 µS, mS, PPM and PPB (TDS), kΩ, MΩ		
Conductivity Temperature	-100 °C to 250 °C	-148 °F to 350 °F (application and sensor dependent)	
Temperature	-99 °C to 350 °C	-99 °F to 350 °F	
Pressure	-40 to 1000 psi		
Level	-9999 to 99999 m, cm, ft, in, %		
Volume	0 to 99999 cm <sup>3</sup> , m <sup>3</sup> , in <sup>3</sup> , ft <sup>3</sup> , gal, L, lb, kg, %		
Salinity	0 to 99.97 PPT		
Dissolved Oxygen	PPM 0-50, % SAT 0-200, 0 to 999.9 TORR		
Dissolved Oxygen Temperature	-99 °C to 350 °C	-99 °F to 350 °F	
Environmental			
Ambient Operating Temperature			
Backlit LCD	-10 °C to 70 °C	14 °F to 158 °F	
Storage Temperature	-15 °C to 70 °C	5 °F to 158 °F	
Relative Humidity	0 to 100% condensing for field mount; 0 to 95% non-condensing for panel mount		
Maximum Altitude	4,000 m (13,123 ft)		
Enclosure Rating	NEMA 4X/IP65 (front face only on panel mount); field mount is 100% NEMA 4X/IP65 when used with universal or integral installation kits		

## Specifications (continued)

### Electrical Requirements

#### Power to Sensors

Voltage	+4.9 to 5.5 VDC @ 25 °C, regulated	
Current	1.5 mA max in loop power mode (up to 2.0 mA with 24 V @ 300 Ω max. loop impedance); 20 mA max when using DC power	
Short Circuit	Protected	
Isolation	Low voltage (< 48V AC/DC) to loop with DC power connected	
No isolation when using loop power only		
Terminal Blocks	Pluggable screw type	14 AWG max wire gauge

### Input Power

DC	10.8 to 35.2 VDC, regulated	
9900 without Relay Module	200 mA @ 10.8 VDC to 35.2 VDC	
9900 with Relay Module	300 mA @ 10.8 VDC to 35.2 VDC	
Overvoltage Protection	48 Volt Transient Protection Device	

#### Current limiting for circuit protection

#### Reverse-Voltage Protection

### Loop Power

#### Loop Power Only

	Max. Loop Impedance	50 Ω @ 12 V	325 Ω @ 18 V	600 Ω @ 24 V
With DC Power Input or with 2nd loop, all the time				
	Max. Loop Impedance	250 Ω @ 12 V	500 Ω @ 18 V	750 Ω @ 24 V

### Relay Specifications

	Dry-Contact Relays (2)	Open Collector (1)
Type	SPDT	N/A
Form	C	N/A
Max. Current Rating	5 A resistive	50 mA DC
Max. Voltage Rating	30 VDC or 250 VAC	30 VDC
Hysteresis	Adjustable (absolute in engineering units) (EUs)	
Latch	Reset in test screen only	
Delay	9999.9 seconds (max.)	
Test Mode	Set On or Off	
Cycle Time	99999 seconds (max.)	
Maximum Pulse Rate	300 pulses/minute	
Proportional Pulse	400 pulses/minute	
Volumetric Pulse Width	0.1 to 3200 s	
Pulse Width Modulation	0.1 to 320 s	

### Input Types

#### Digital (S<sup>3</sup>L) or AC frequency

#### 4 to 20 mA input via the 8058-1

#### pH/ORP input via the Digital (S<sup>3</sup>L) output from the 2750/2751 pH/ORP Sensor Electronics

#### Raw Conductivity/Resistivity input directly from Signet Conductivity/Resistivity electrodes via Direct Conductivity/Resistivity Module or via 2850

### Input Specifications

Digital (S <sup>3</sup> L)	Serial ACSII, TTL level, 9600 bps	
Frequency Input		
	Sensitivity	80 mV @ 5 Hz, gradually increasing with frequency
	Span	0.5 Hz to 1500 Hz @ TTL level input
	Accuracy	± 0.5% or reading max error @ 25 °C
	Resolution	1 μS
	Repeatability	± 0.2% of reading

## Specifications (continued)

### Input Specifications continued

#### Power Supply

Rejection	±1 µA per volt
Short Circuit	Protected

Update Rate (1/frequency) + 150 ms

#### Direct Conductivity/Resistivity Module (3-9900.394)

Accuracy	Conductivity +/- 2% of Reading
	Temperature 0.5 °C
Resolution	Conductivity 0.1% of Reading
	Temperature <0.2 °C
Update Rate	2.5 Seconds
Compatible Electrodes	All GF Signet Sensors

### Output Specifications

#### Current Output - One (1); Two (2) with 4 to 20 mA Output Module

Current Loop Output Standard	ANSI-ISA 50.00.01 Class H		
Current Output	4 to 20 mA, isolated, fully adjustable and reversible		
Span	3.8 to 21 mA		
Zero	4.0 mA factory set; user programmable from 3.8 to 5.0 mA		
Full Scale	20.00 mA factory set; user programmable from 19.0 to 21.0 mA		
Accuracy	±32 µA max. error @ 25 °C @ 24 VDC		
Resolution	6 µA or better		
Temperature Drift	±1 µA per °C		
Power Supply Rejection	±1 µA per V		
Isolation	Low voltage (< 48 VAC/DC)		
Voltage	12 to 32 VDC ±10%		
Max. Impedance (with DC power input)	250 Ω @ 12 VDC	500 Ω @ 18 VDC	750 Ω @ 24 VDC
Max. Impedance (no DC power input)	50 Ω @ 12 VDC	325 Ω @ 18 VDC	600 Ω @ 24 VDC
Update Rate	150 mS nominal		
Short circuit and reverse polarity protected			
Adjustable Span	Reversible		
Error Condition	Selectable error condition 3.6 or 22 mA		
Actual update rate determined by sensor type			
Test Mode	Increment to desired current (range 3.8 to 21.00 mA)		

### Shipping Weights

Base Unit	0.63 kg	1.38 lb
Modbus Module	0.16 kg	0.35 lb
H COMM Module	0.16 kg	0.35 lb
Conductivity Module	0.16 kg	0.35 lb
Relay Module	0.19 kg	0.41 lb
Batch Module	0.16 kg	0.35 lb
4 to 20 Output Module	0.16 kg	0.35 lb
Rear Enclosure, Hinged cover	0.30 kg	0.65 lb
Rear Enclosure, Flat cover	0.28 kg	0.60 lb

### Standards and Approvals

CE, UL, CUL, FCC
RoHS Compliant, China RoHS
Lloyd's Register
Manufactured under ISO 9001 and ISO 14001 for Environmental Management and OHSAS 18001 for Occupational Health and Safety

## Dimensions - Panel Mount

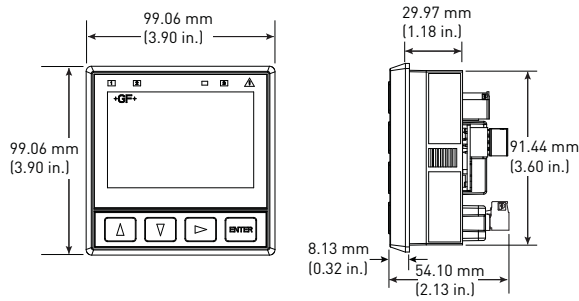

## Dimensions - Rear Enclosure

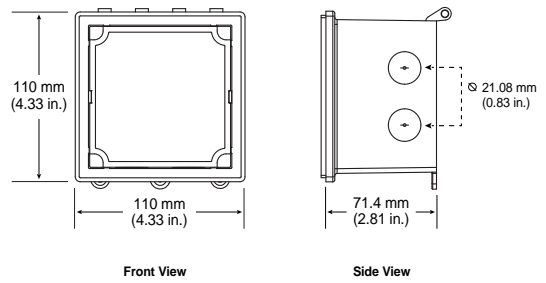

## Integral Mount

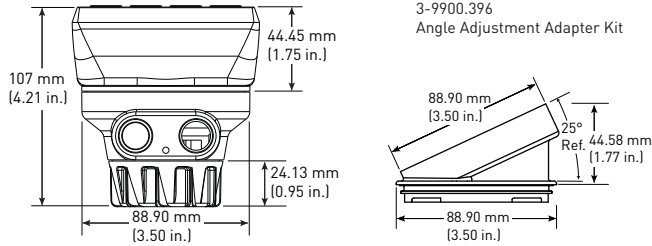

## Hinged Cover

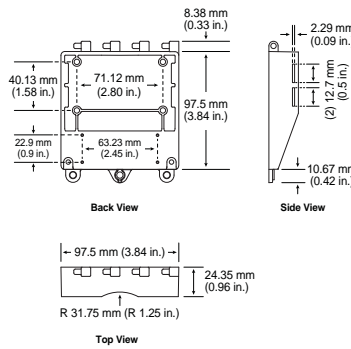

## Flat Cover

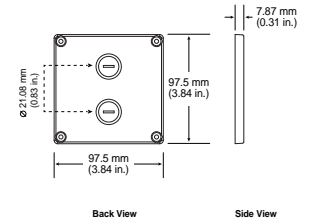





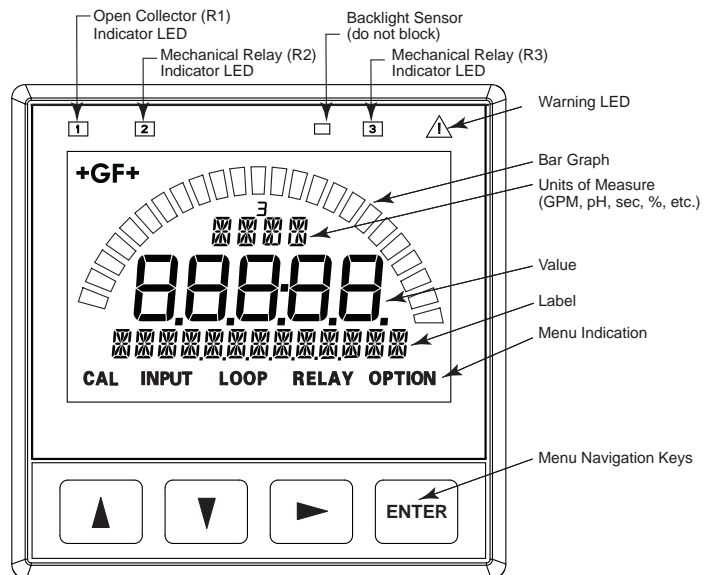





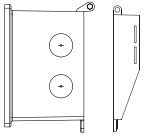



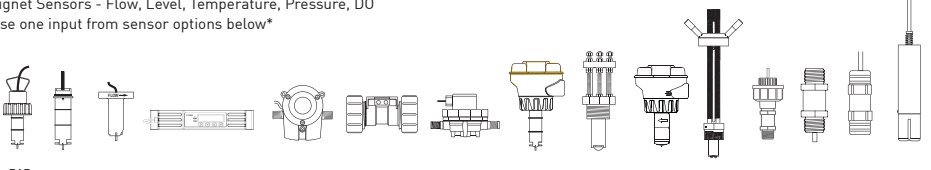
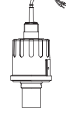

Sensor model	9900 Generation			
	I	II	III	IV
515/8510	X	X	X	X
525	X	X	X	X
U1000				X
2000	X	X	X	X
2100	X	X	X	X
2250	X	X	X	X
2350	X	X	X	X
2450	X	X	X	X
2507	X	X	X	X
2536/8512	X	X	X	X
2537-5	X	X	X	X
2540	X	X	X	X
2551	X	X	X	X
2552	X	X	X	X
2610-51	X	X	X	X
2610 + 8058	X	X	X	X
2724-2726	X	X	X	X
2734-2736	X	X	X	X
2750	X	X	X	X
2751	X	X	X	X
2756-2757	X	X	X	X
2764-2767	X	X	X	X
2774-2777	X	X	X	X
2819-2823	X	X	X	X
2839-2842	X	X	X	X
2850	X	X	X	X
4150 + 8058	X	X	X	X





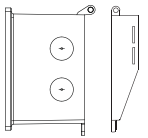

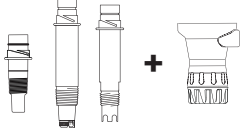
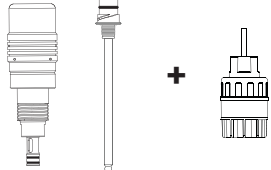

9900 Module	9900 Generation			
	I	II	III	IV
H COMM	X	X	X	X
Relay	X	X	X	X
Conductivity/Resistivity	X	X	X	X
Batch		X	X	X
4 to 20 mA Output			X	X
Modbus	X	X	X	X

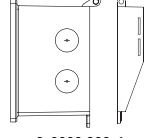

All possible segments shown in this illustration. The instrument's software controls which segments are shown at any particular time. Only the bar graph segment outline and GF logo are visible when the unit is turned off.

Panel Mount	Pipe, Tank, Wall Mount	Field (Integral) Mount
<b>Signet Model 9900 Transmitter</b> (Includes mounting bracket and panel gasket) 	<b>Signet Model 9900 Transmitter with Rear Enclosure</b>   3-9900.399-1	<b>Signet Model 9900 Transmitter with Junction Box (varies with sensor and installation)</b>     
Signet Sensors - Flow, Level, Temperature, Pressure, DO Use one input from sensor options below* 		<b>2270 with 8058 iGo Converter plus other 4 to 20 mA</b>  
Signet Fittings - See individual sensor data sheets		All sold separately

Panel Mount	Pipe, Tank, Wall Mount	Field (Integral) Mount
<b>Signet Model 9900 Transmitter</b> (Includes mounting bracket and panel gasket) 	<b>Signet Model 9900 Transmitter with Rear Enclosure</b>   3-9900.399-1	<b>Signet Model 9900 Transmitter with Junction Box (varies with sensor and installation)</b>    
Signet Sensors - pH/ORP Use one input from sensor options below* with 2751 Smart Sensor Electronics 		Signet Wet-Tap Electrode Model 2756, 2757 and 3719 Wet-Tap with 2751 Smart Sensor Electronics 
Signet Fittings - See individual sensor data sheets		All sold separately

Panel Mount	Pipe, Tank, Wall Mount	Field (Integral) Mount
<b>Signet Model 9900 Transmitter</b> (Includes mounting bracket and panel gasket) 	<b>Signet Model 9900 Transmitter with Rear Enclosure</b>   3-9900.399-1	<b>Signet Model 9900 Transmitter with 3-9900.396 Angle Adapter and Junction Box (varies with sensor and installation)</b>    
Signet Sensors - Conductivity/Resistivity and Salinity Electrodes Use one input from electrode options below* with Conductivity Module or 2850 Sensor Electronics 		
Signet Fittings - See individual sensor data sheets		All sold separately

\* See individual sensor datasheets for additional information  
 \*\*3-9900.396 is required with the Conductivity Module and either 3-8050 or 3-8052 to provide sufficient clearance

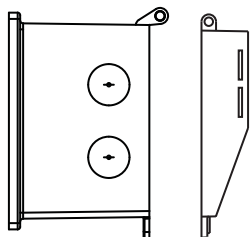

3-9900.399-1  
 (159 001 834)  
 Rear Enclosure Kit,  
 hinged cover



3-9900.399-2  
 (159 001 835)  
 Rear Enclosure Kit,  
 flat cover

3-9900-1  
 (159 001 696)  
 Field Mount  
 3-9900-396  
 (159 001 701)  
 Angle Adjustment  
 Adapter Kit  
 3-8051 (159 000 187)  
 3-8051-1 (159 001 755)  
 3-8051-2 (159 001 756)  
 Flow Sensor  
 Integral Mounting Kit

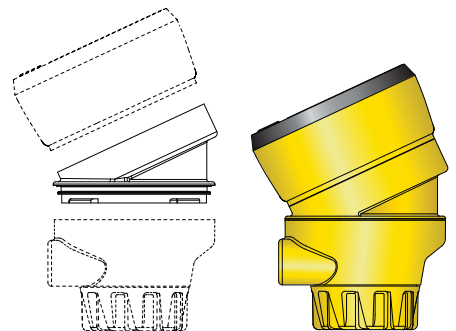

## Plug in Modules

Optional modules and accessories are available for the 9900:

- Base Unit (required)
- Slot for optional H COMM or Modbus Modules
- Slot for optional Conductivity/Resistivity, Batch, or 4 to 20 mA Output Module
- Slot for optional Relay Module (not available on field mount)

Each item is ordered separately.

Modules are field-replaceable at any time.

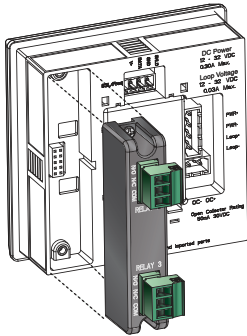

### Relay Module (Panel Installations Only) (3-9900.393)

This module adds two programmable dry-contact relays to the standard Open Collector output in the base unit.

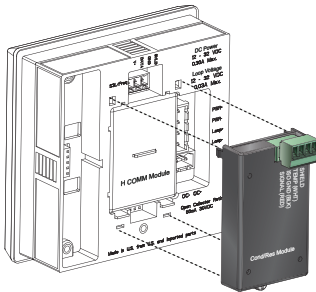

### Direct Conductivity/Resistivity Module (3-9900.394)

The Direct Conductivity/Resistivity Module interfaces Signet 2819-2823 and 2839-2842 Conductivity electrodes directly to the 9900.

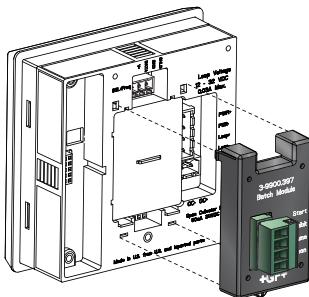

### Batch Module (3-9900.397)

The Batch Module adds batch capability to the 9900 Transmitter (Generation II and newer). It is compatible with all Signet flow sensors.

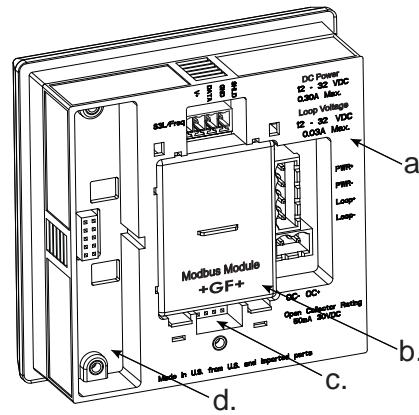

3-9900.270-M2



3-9900.270-M3

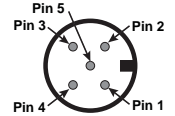

3-9900.270-M4

Coming Soon



### Modbus Modules (3-9900.270-MX)

These Modules allow the 9900 to communicate with Automation systems using the Modbus serial RS485 Protocol.

- 3-9900.270-M1 - Modbus Module with 6 Wire Cable Assembly
- 3-9900.270-M2 - Terminal Block Connections (Panel Mount Only)
- 3-9900.270-M3 - M12 Connector (Field Mount Only)
- 3-9900.270-M4 - Coming Soon - Modbus Module with 5 Wire Cable Assembly

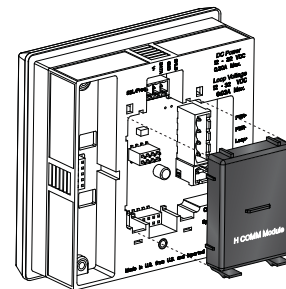

### H COMM Module (HART®) (3-9900.395)

The H COMM Module enables communication between the 9900 and a HART® enabled device.

(Not available for use on 3-9900-1BC Batch Controller)

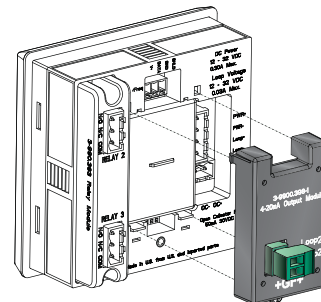

### 4 to 20 mA Output Module (3-9900.398-1)

The 4 to 20 mA Output Module adds a second 4 to 20 mA Output to the 9900 Transmitter (Generation III and later). Each of the outputs can be used to output the primary and/or secondary measurement.

## Ordering Information

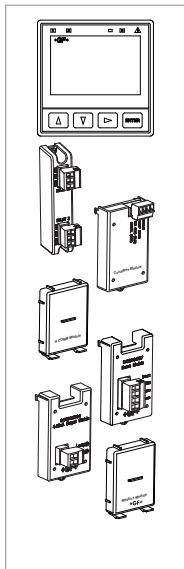

Mfr. Part No	Code	Description
9900 Base Unit - Single Channel, Multi-Parameter, 4 to 20 mA, Open Collector, DC power		
3-9900-1P	<b>159 001 695</b>	9900 Panel Mount Transmitter
3-9900-1	<b>159 001 696</b>	9900 Field Mount Transmitter
3-9900-1BC	<b>159 001 770</b>	Batch Controller System
Optional Accessory Modules		
3-9900.270-M1	<b>159 200 120</b>	Modbus Module with 6 Wire Cable Assembly
3-9900.270-M2	<b>159 200 121</b>	Modbus Module with Terminal Block Assembly (Panel Mount Only)
3-9900.270-M3	<b>159 200 122</b>	Modbus Module with M12 Connector Assembly (Field Mount Only)
3-9900.270-M4	<b>Coming Soon</b>	Modbus Module with 5 Wire Cable Assembly
3-9900.393	<b>159 001 698</b>	Relay Module - 2 DCR (Dry-contact relays)
3-9900.394	<b>159 001 699</b>	Direct Conductivity/Resistivity Module
3-9900.395	<b>159 001 697</b>	H COMM Module
3-9900.397	<b>159 310 163</b>	Batch Module
3-9900.398-1	<b>159 001 784</b>	4 to 20 mA Output Module*

\*Module adds a second 4 to 20 mA output. One 4 to 20 mA output is included in the base unit.

## Accessories and Replacement Parts

Mfr. Part No	Code	Description
6682-0204	<b>159 001 709</b>	Conductivity Module Plug, 4 Pos, Right Angle
6682-1102	<b>159 001 710</b>	DC Power Plug, 2 Pos, Right Angle
6682-1103	<b>159 001 711</b>	Relay Module Plug, 3 Pos, Right Angle
6682-1104	<b>159 001 712</b>	Loop Power Plug, 4 Pos, Right Angle
6682-3104	<b>159 001 713</b>	Freq/S <sup>3</sup> L Plug, 4 Pos, Right Angle
6682-3004	<b>159 001 725</b>	Terminal Block Plug
7310-1024	<b>159 873 004</b>	24 VDC Power Supply, 0.42 A, 10W
7310-2024	<b>159 873 005</b>	24 VDC Power Supply, 1.0 A, 24W
7310-4024	<b>159 873 006</b>	24 VDC Power Supply, 1.7 A, 40W
7310-6024	<b>159 873 007</b>	24 VDC Power Supply, 2.5 A, 60W
7310-7024	<b>159 873 008</b>	24 VDC Power Supply, 4.0 A, 96W
3-0252	<b>159 001 808</b>	0252 Configuration Tool
3-8050	<b>159 000 184</b>	Universal Mount Kit
3-8050.396	<b>159 000 617</b>	RC Filter kit (for relay use), 2 per kit
3-8051	<b>159 000 187</b>	Flow Sensor Integral Mounting Kit, NPT, Valox
3-8051-1	<b>159 001 755</b>	Flow Sensor Integral Mounting Kit, NPT, PP
3-8051-2	<b>159 001 756</b>	Flow Sensor Integral Mounting Kit, NPT, PVDF
3-8052	<b>159 000 188</b>	¾ in. Integral Mount Kit
3-8058-1	<b>159 000 966</b>	I-Go® Signal Converter, wire-mount
3-8058-2	<b>159 000 967</b>	I-Go® Signal Converter, DIN rail mount
3-9000.392-1	<b>159 000 839</b>	Liquid Tight Connector Kit, NPT (1 pc.)
3-9900.270-CB1	<b>159 200 123</b>	Replacement Wire Cable Assembly for M1
3-9900.270-CB2	<b>159 200 124</b>	Replacement Terminal Block Assembly for M2
3-9900.270-CB3	<b>159 200 125</b>	Replacement M12 Connector Assembly for M3
3-9900.270-CB4	<b>Coming Soon</b>	Replacement Cable Assembly for M4
3-9900.390	<b>159 001 714</b>	Standard Connector Kit, Right Angle, 9900 Transmitter
5541-5005	<b>159 855 021</b>	5 meter (16 ft) M12 cable
5541-5010	<b>159 855 022</b>	10 meter (32 ft) M12 cable
3-9900.391	<b>159 001 715</b>	Optional Connector Kit, In-Line, 9900 Transmitter
3-9900.392	<b>159 001 700</b>	Wall Mount Accessory Kit for 9900
3-9900.396	<b>159 001 701</b>	Angle Adjustment Adapter Kit (for Field Mounting)
3-9900.399-1	<b>159 001 834</b>	Rear enclosure kit, hinged cover
3-9900.399-2	<b>159 001 835</b>	Rear enclosure kit, flat cover

**3-9900.099 Rev N (09/18)**

© Georg Fischer Signet LLC

3401 Aero Jet Avenue, El Monte, CA 91731-2882 U.S.A. • Tel. (626) 571-2770 • Fax (626) 573-2057 • www.gfsignet.com • e-mail: signet.ps@georgfischer.com

Specifications subject to change without notice. All rights reserved. All corporate names and trademarks stated herein are the property of their respective companies.



# EC Declaration of conformity

The undersigned, representing the following:

**Manufacturer:** Georg Fischer Signet LLC  
3401 Aerojet Ave.  
El Monte, CA 91731

**Manufacturing site(s):** Same as above

herewith declares that the product: **159 001 69a GF Signet 3-9900-X Single Channel, Multi-Parameter Transmitter** is in conformity with the provisions of the Electromagnetic Compatibility Directive (**EMC 2004/108/EC**) and the Low-Voltage Directive (**LV 2006/95/EC**) when installed in accordance with the installation instructions contained in the product documentation. Tests, according to the standards listed below, were performed as a system with a Georg Fischer Signet configuration.

Where a may be 5 or 6 and X may be 1 or 1P

**Standard(s) to which the product conforms:**

EN 61010-1:2001  
EN 55011:2007  
EN 61326:2006  
EN 61000-6-2:2005

Quality Management System according to ISO 9001, ISO 14001, and ISO 18001

**Description of the product:**

159 001 69a (3-9900-X) is a single channel interface for many different parameters that output a 4 to 20 mA signal.

This declaration of conformity is valid for the above-mentioned products manufactured from batch 2011/09 on and later.

**Signature**



Name: Steve Wells, PhD  
Position: Engineering Manager  
Date: 2012/03/30